

IGCSE MATHEMATICS FORMULAE SHEET – HIGHER TIER

Pythagoras' Theorem

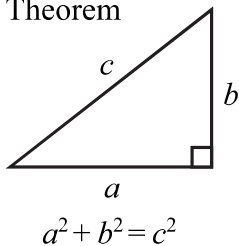

Volume of cone = $\frac{1}{3} \pi r^2 h$

Volume of sphere = $\frac{4}{3} \pi r^3$

Curved surface area of cone = $\pi r l$

Surface area of sphere = $4 \pi r^2$

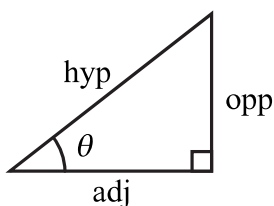
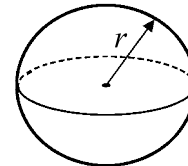
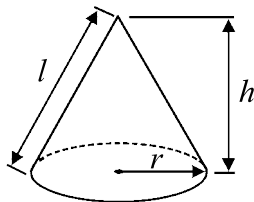

adj = hyp \times cos θ
opp = hyp \times sin θ
opp = adj \times tan θ

or $\sin \theta = \frac{\text{opp}}{\text{hyp}}$

$\cos \theta = \frac{\text{adj}}{\text{hyp}}$

$\tan \theta = \frac{\text{opp}}{\text{adj}}$

In any triangle ABC

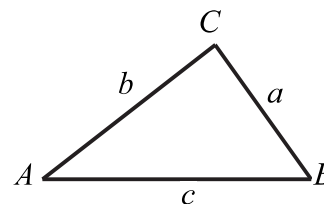

Sine rule: $\frac{a}{\sin A} = \frac{b}{\sin B} = \frac{c}{\sin C}$

Cosine rule: $a^2 = b^2 + c^2 - 2bc \cos A$

Area of triangle = $\frac{1}{2} ab \sin C$

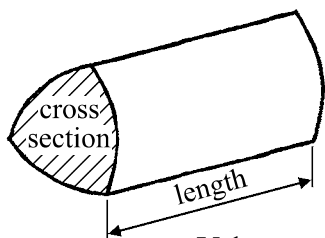

Volume of prism = area of cross section \times length

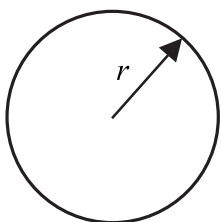

Circumference of circle = $2 \pi r$

Area of circle = πr^2

Area of a trapezium = $\frac{1}{2} (a + b) h$

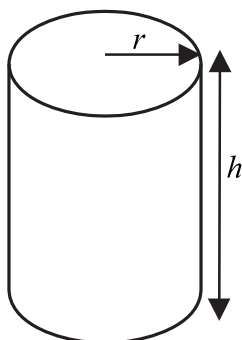
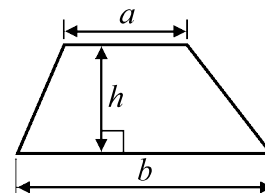

Volume of cylinder = $\pi r^2 h$

Curved surface area of cylinder = $2 \pi r h$

The Quadratic Equation
The solutions of $ax^2 + bx + c = 0$, where $a \neq 0$, are given by

$$x = \frac{-b \pm \sqrt{b^2 - 4ac}}{2a}$$



Answer ALL TWENTY THREE questions.

Write your answers in the spaces provided.

You must write down all the stages in your working.

- 1 (a) Use your calculator to work out the value of

$$\frac{24.1}{8.4 - 7.8} - 6.2^2$$

Write down all the figures on your calculator display.

.....
(2)

- (b) Give your answer to part (a) correct to 3 significant figures.

.....
(1)

(Total for Question 1 is 3 marks)



2

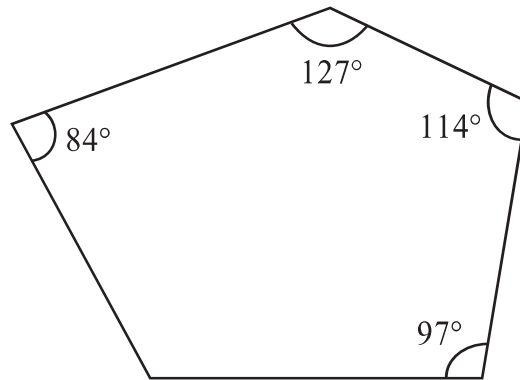

Diagram **NOT**
accurately drawn

Four of the angles of a pentagon are 97° , 114° , 127° and 84° .

Work out the size of the fifth angle.

.....^o

(Total for Question 2 is 4 marks)



3 (a) Factorise $w^2 - 9w$.

.....
(2)

(b) Solve $5x - 1 = 2x - 7$

$x =$

(3)

(c) Expand and simplify $(y - 7)(y + 3)$.

.....
(2)

(Total for Question 3 is 7 marks)



- 4 Every morning, Samath has one glass of fruit juice with his breakfast. He chooses at random orange juice or pineapple juice or mango juice. The probability that he chooses orange juice is 0.6
The probability that he chooses pineapple juice is 0.3

(a) Work out the probability that he chooses mango juice.

.....
(2)

(b) There are 30 days in April.

Work out an estimate for the number of days in April on which Samath chooses orange juice.

.....
(2)

(Total for Question 4 is 4 marks)

- 5 Show that $\frac{5}{6} - \frac{3}{4} = \frac{1}{12}$

(Total for Question 5 is 2 marks)



6

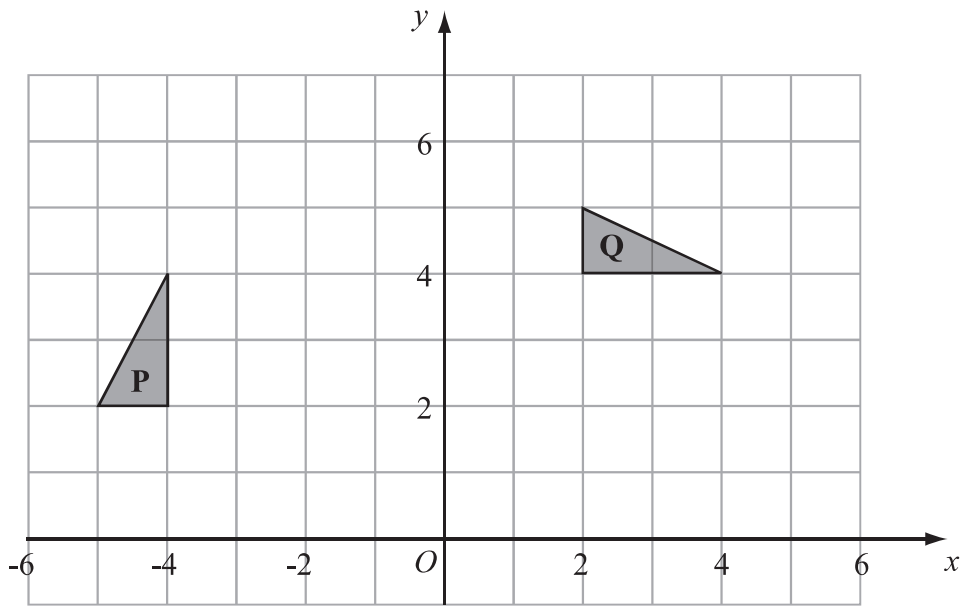

(a) Describe fully the single transformation which maps triangle P onto triangle Q.

(3)

(b) Reflect triangle Q in the line $y = x$.

Label the new triangle R.

(2)

(Total for Question 6 is 5 marks)

7 The perimeter of a triangle is 90 cm.
The lengths of the sides of the triangle are in the ratios 3 : 5 : 7

Work out the length of the longest side of the triangle.

..... cm

(Total for Question 7 is 3 marks)



- 8 $\mathcal{E} = \{2, 3, 4, 5, 6, 7, 8, 9, 10, 11, 12\}$
 $A = \{\text{odd numbers}\}$
 $P = \{\text{prime numbers}\}$

List the members of the set

(i) $A \cap P,$

.....

(ii) $A \cup P.$

.....

(Total for Question 8 is 2 marks)

- 9 Ella invested \$8000 for 3 years at 5% per annum **compound interest**.

Calculate the value of her investment at the end of 3 years.

\$

(Total for Question 9 is 3 marks)



10 This rule can be used to work out the fare, in dirhams, for a taxi journey in Dubai.

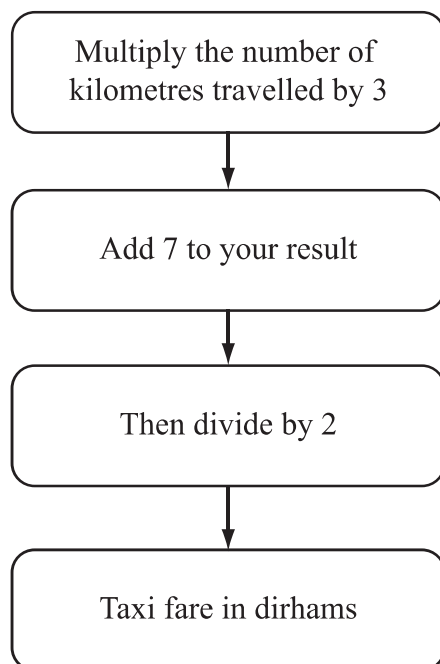

Find a formula for the fare, C dirhams, for a taxi journey of d kilometres.

.....
(Total for Question 10 is 3 marks)



11 The table shows information about the weights of 80 parcels.

Weight (w kg)	Frequency
$0 < w \leq 2$	8
$2 < w \leq 4$	14
$4 < w \leq 6$	26
$6 < w \leq 8$	17
$8 < w \leq 10$	10
$10 < w \leq 12$	5

(a) Work out an estimate for the total weight of the 80 parcels.

..... kg

(3)

(b) Complete the cumulative frequency table.

Weight (w kg)	Cumulative frequency
$0 < w \leq 2$	
$0 < w \leq 4$	
$0 < w \leq 6$	
$0 < w \leq 8$	
$0 < w \leq 10$	
$0 < w \leq 12$	

(1)



(c) On the grid, draw a cumulative frequency graph for your table.

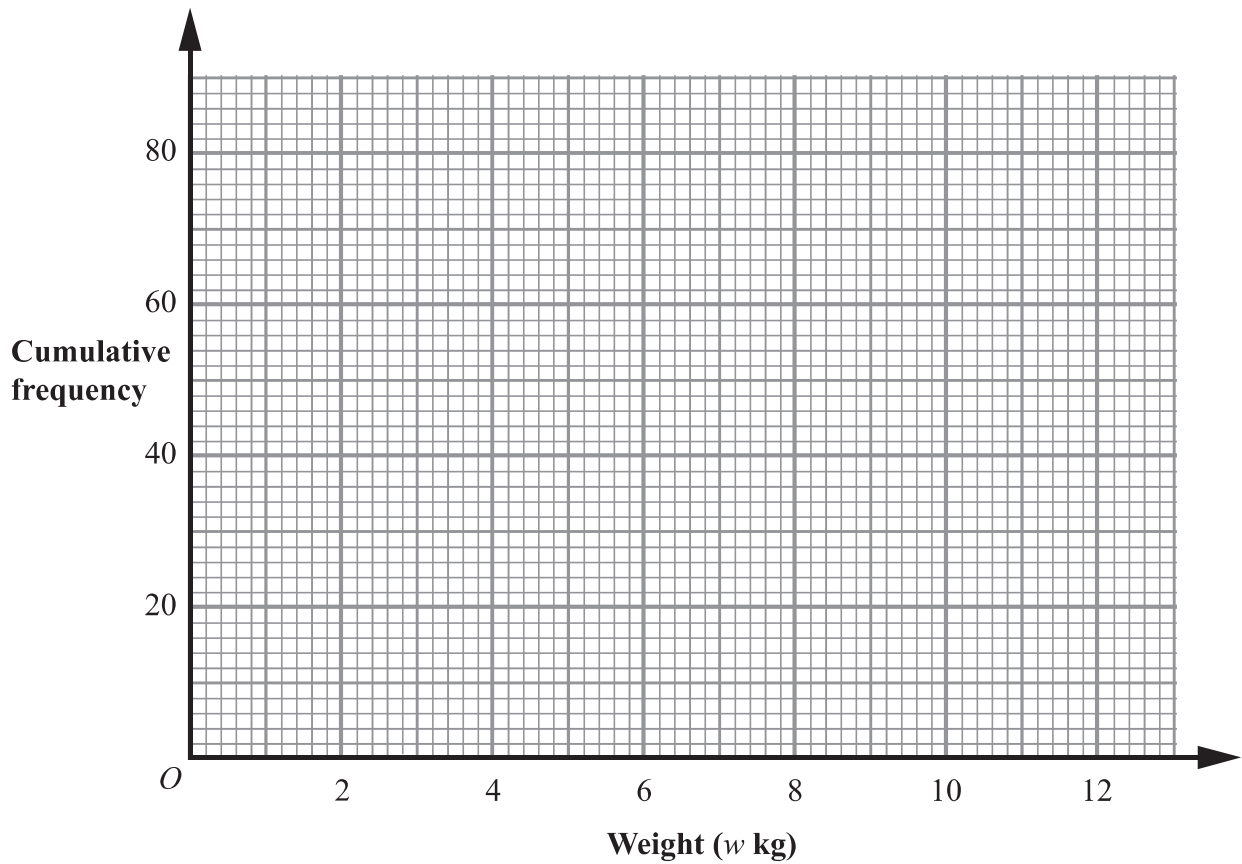

(2)

(d) Use the graph to find an estimate for the number of parcels which weighed less than 5.2 kg.

.....
(2)

(Total for Question 11 is 8 marks)

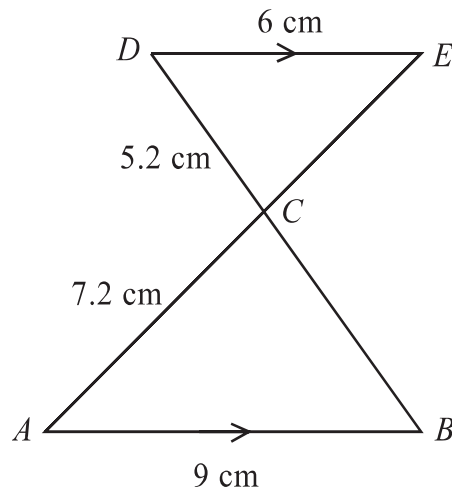

12

Diagram **NOT**
accurately drawn

AB is parallel to DE .
 ACE and BCD are straight lines.
 $AB = 9$ cm.
 $AC = 7.2$ cm.
 $CD = 5.2$ cm.
 $DE = 6$ cm.

(a) Calculate the length of BC .

..... cm
 (2)

(b) Calculate the length of CE .

..... cm
 (2)

(Total for Question 12 is 4 marks)

12



P 3 8 5 7 9 A 0 1 2 2 4

13 Solve $\frac{2x-1}{4} + \frac{x-1}{5} = 2$

$x = \dots\dots\dots$

(Total for Question 13 is 4 marks)

14 $y = 1.8$ correct to 1 decimal place.

Calculate the lower bound for the value of $4y + 1$

$\dots\dots\dots$

(Total for Question 14 is 2 marks)



15 (a) Here is a shape made from a rectangle and a semicircle.

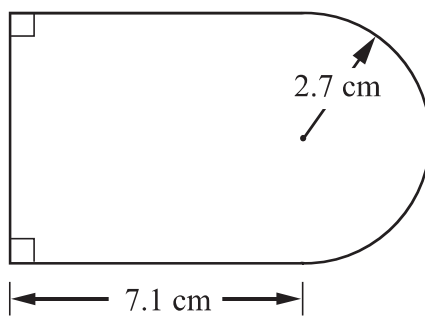

Diagram **NOT**
accurately drawn

The length of the rectangle is 7.1 cm.
The radius of the semicircle is 2.7 cm.

Work out the area of the shape.
Give your answer correct to 3 significant figures.

..... cm²
(4)



(b) Here is another shape made from a rectangle and a semicircle.

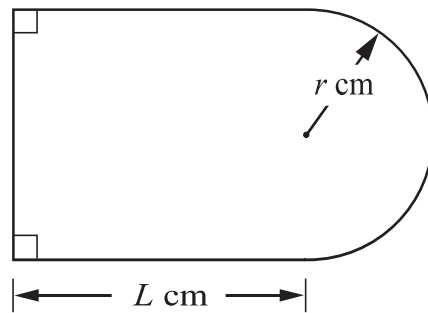

Diagram **NOT**
accurately drawn

The length of the rectangle is L cm.

The radius of the semicircle is r cm.

The perimeter, P cm, of the shape is given by the formula

$$P = \pi r + 2L + 2r$$

Make r the subject of the formula $P = \pi r + 2L + 2r$.

$$r = \dots\dots\dots$$

(3)

(Total for Question 15 is 7 marks)



16

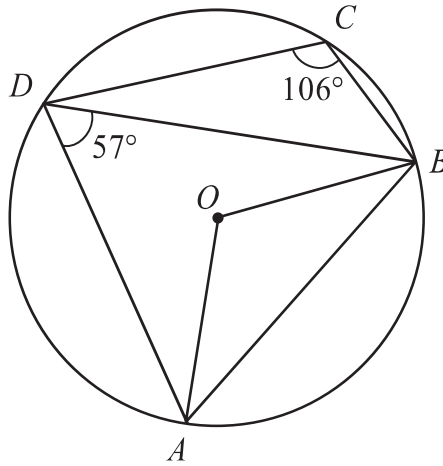

Diagram **NOT** accurately drawn

A, B, C and D are points on a circle, centre O .
 Angle $ADB = 57^\circ$.
 Angle $BCD = 106^\circ$.

(a) (i) Calculate the size of angle AOB .

.....
 °

(ii) Give a reason for your answer.

.....

 (2)

(b) Calculate the size of angle BAD .

.....
 °
 (1)

(Total for Question 16 is 3 marks)



- 17 Here are seven counters.
Each counter has a number on it.



Ali puts the seven counters in a bag.
He takes, at random, a counter from the bag and does **not** replace the counter.
He then takes, at random, a second counter from the bag.

Calculate the probability that

- (i) the number on the second counter is 2 more than the number on the first counter,

-
- (ii) the number on the second counter is 1 more than the number on the first counter.

.....

(Total for Question 17 is 5 marks)



18

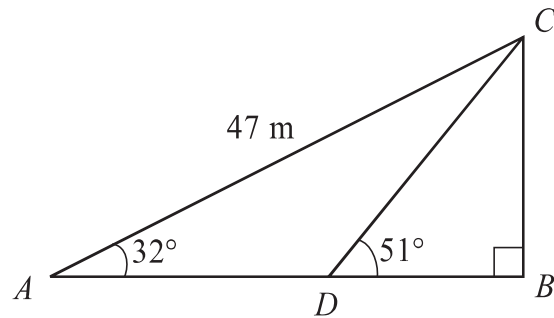

Diagram **NOT**
accurately drawn

Triangle ABC is right-angled at B .

Angle $BAC = 32^\circ$

$AC = 47\text{ m}$.

D is the point on AB such that angle $BDC = 51^\circ$

Calculate the length of BD .

Give your answer correct to 3 significant figures.

..... m

(Total for Question 18 is 5 marks)



19 P is directly proportional to the cube of Q .

When $Q = 15$, $P = 1350$

(a) Find a formula for P in terms of Q .

$$P = \dots\dots\dots$$

(3)

(b) Calculate the value of P when $Q = 20$

$$P = \dots\dots\dots$$

(1)

(Total for Question 19 is 4 marks)

20 $x = a \times 10^n$ where n is an integer and $\sqrt{10} \leq a < 10$

Find, in standard form, an expression for x^2 .

Give your expression as simply as possible.

.....

(Total for Question 20 is 3 marks)



21

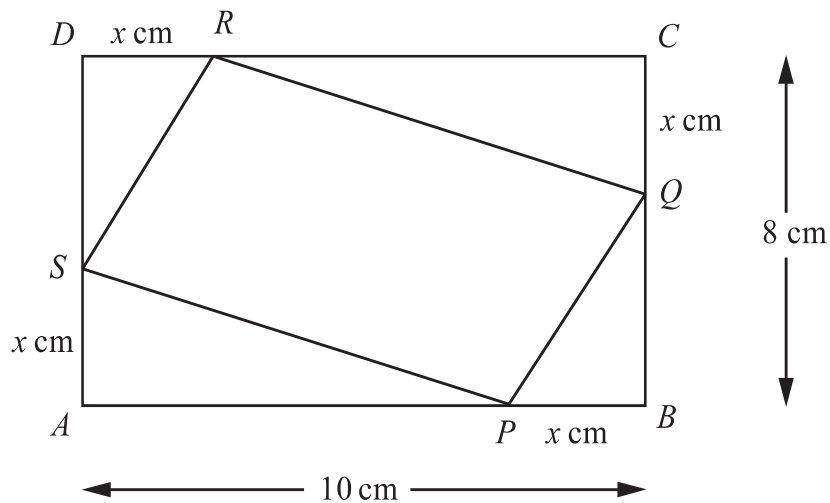

$ABCD$ is a rectangle.

$AB = 10$ cm.

$BC = 8$ cm.

P , Q , R and S are points on the sides of the rectangle.

$BP = CQ = DR = AS = x$ cm.

(a) Show that the area, A cm², of the quadrilateral $PQRS$ is given by the formula

$$A = 2x^2 - 18x + 80$$

(3)



(b) For $A = 2x^2 - 18x + 80$

(i) find $\frac{dA}{dx}$,

(ii) find the value of x for which A is a minimum.

$x =$

(iii) Explain how you know that A is a minimum for this value of x .

.....
.....
(5)

(Total for Question 21 is 8 marks)



22 Solve the simultaneous equations

$$y = 2x - 3$$

$$x^2 + y^2 = 2$$

.....
(Total for Question 22 is 6 marks)



23

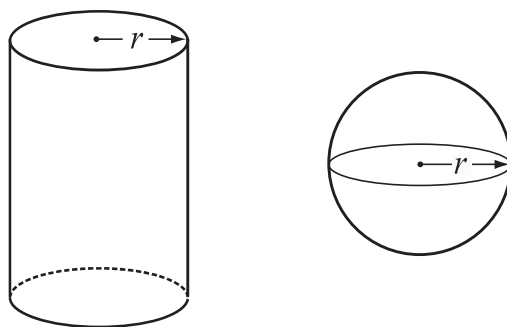

Diagram **NOT**
accurately drawn

The diagram shows a solid cylinder and a solid sphere.
The cylinder has radius r .
The sphere has radius r .

Given that $\frac{\text{Total surface area of cylinder}}{\text{Surface area of sphere}} = 2$

find the value of $\frac{\text{Volume of cylinder}}{\text{Volume of sphere}}$

.....
(Total for Question 23 is 5 marks)

TOTAL FOR PAPER IS 100 MARKS

